



Premium Shell Standard Booth

KINTEX 1

Vanessa Min

070-4335-1388

mkc@inaradesign.co.kr

Skype ID : min.vanessa / wechat ID : vanessa23min

KINTEX 2

Vanessa Min

070-4335-1388

mkc@inaradesign.co.kr

Skype ID : min.vanessa / wechat ID : vanessa23min

Basic Shell Stand_4Booth(Peninsula Type)

(Measure : mm)



Perspective

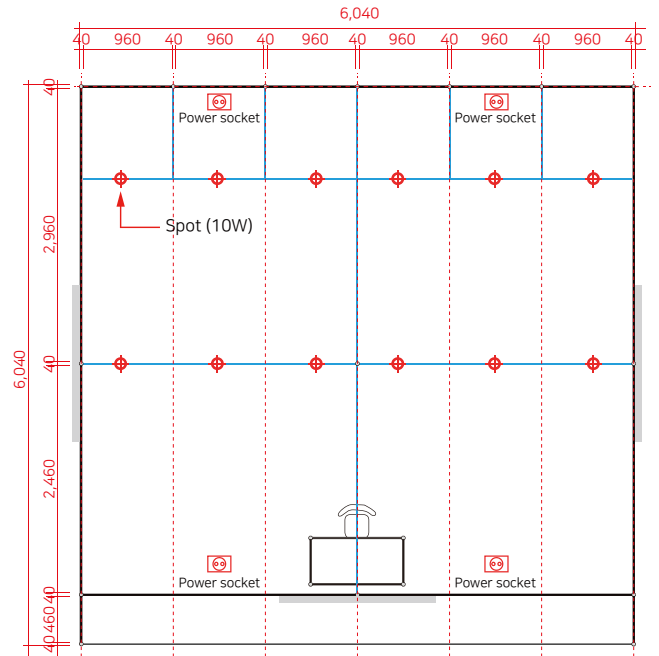

Top View

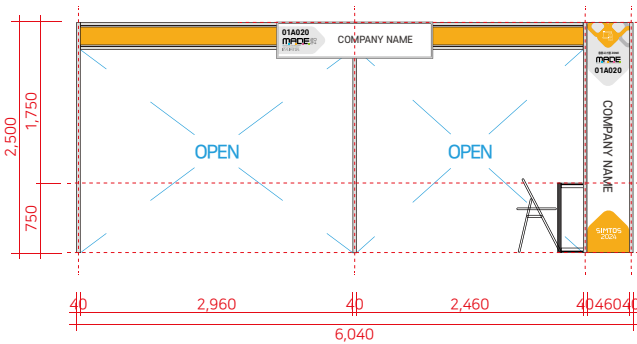

Left View

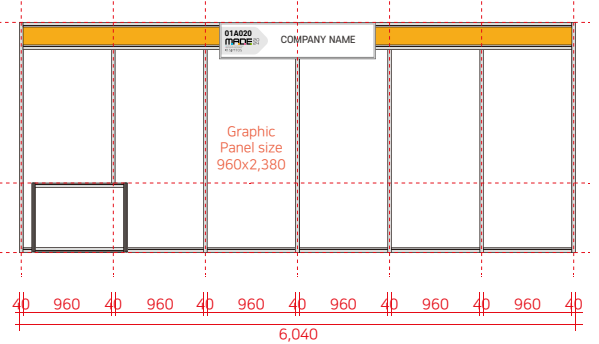

Front View

Extend Elevation

Booth Particulars		
1.Booth structure(octaneum)	W: 6m x D: 5.5m x H: 2.5m	1set
2.Companyname Sign board	W: 1.7m x H: 0.4m	3ea
3.Wall side sign(Banner pillar)	W:0.46 x H:2.5m	2ea
4.Information	Table+Chair (W:1m x 0.5m x 0.75m)	1set
5.Spot light	Spot (10W)	12ea
6.Power sockek	220V, 2holes(per booth)	4ea
7.Flooring(Pytex)	Fire resistant A-class W: 6m x D: 6m	36㎡
8.Electric power	220V (Single-phase)	4Kw

Booth Particulars	
Block Information Desk Size : 1,000x500x750(H)	Folding Chair
Pytex (Fire resistant)	Power socket 2Holes (220V)

Basic Shell Stand_4Booth (Corner Type)

Wall size changes according to Booth Location

(Measure : mm)

If the neighboring booth is a Space-only exhibitor, side walls between you and your neighbor may become blocked. Further guidance will be provided for any changes.

2sided open booth with a blocked left wall

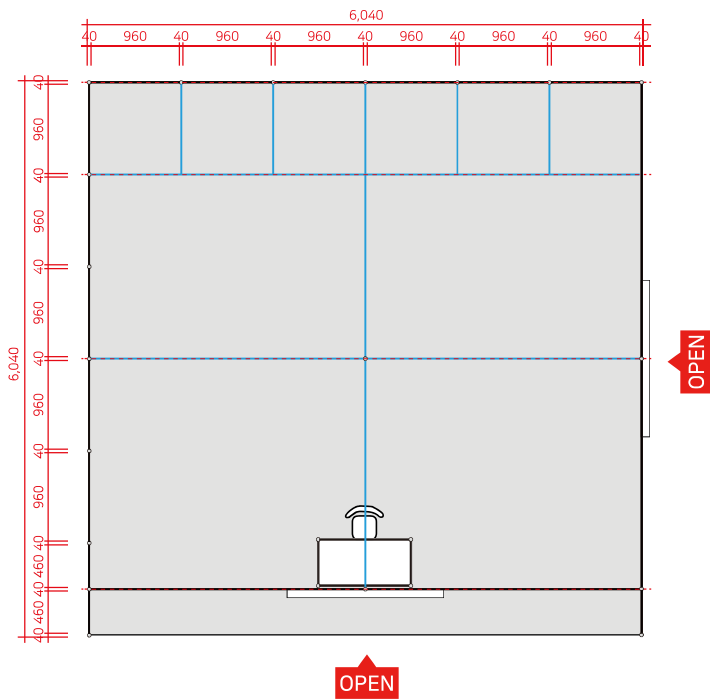

2sided open booth with a blocked right wall

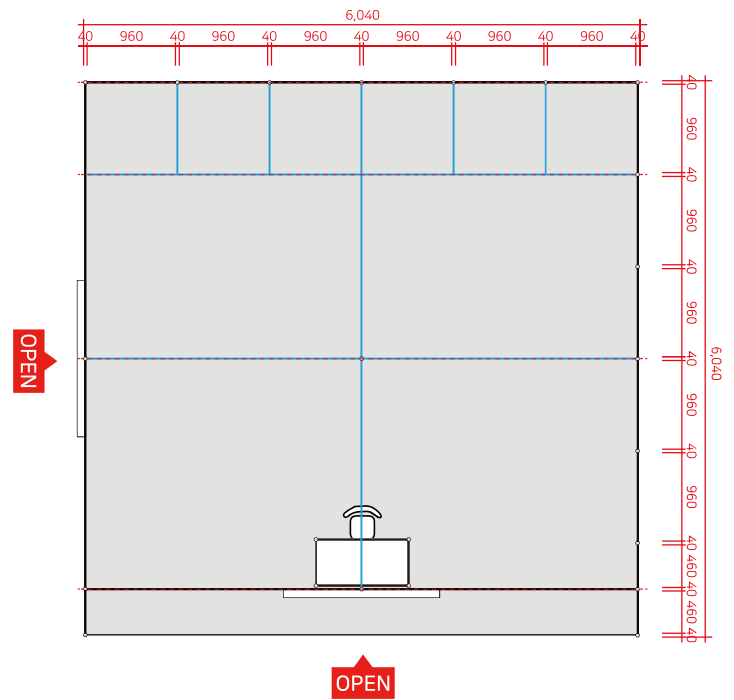

1sided open booth with a blocked right and left wall

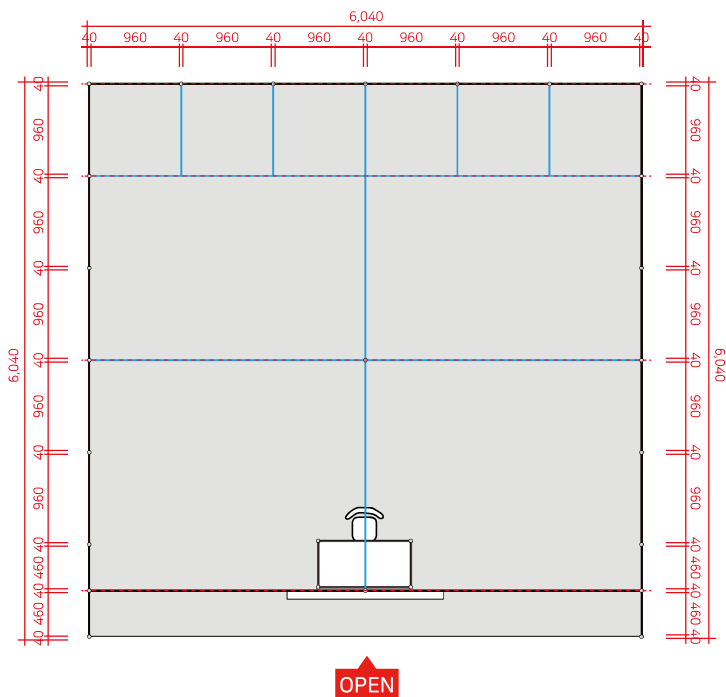

Paid Option List

A Lighting Tower

A-1 Block Tower

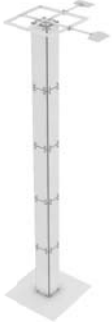

(H:3,600mm)

Tower fee : \$ 385.00
Light fee : \$ 77.00
Up to 4 lights are available.

A-2 Trus Tower

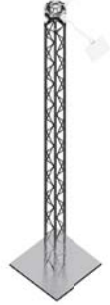

(H:3,000mm)

Tower fee : \$ 275.00
Light fee : \$ 77.00
Up to 4 lights are available.

B Table

B-1 Block System



(W:900 X D:400 X H:900)
Table fee : \$ 88.00

B-2 Octanium System



(W:1,000 X D:500 X H:750)
Table fee : \$ 44.00

C Lighting & Power Socket

C-1



Spot 10W
fee : \$ 35.00

C-2

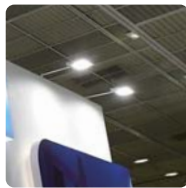

LED 30W
fee : \$ 77.00

C-3



LED PAR 370W
fee : \$ 605.00

C-4



220V/2P Power Socket
fee : \$ 33.00

D Add Logo fee : \$ 110.00

Logo

data in .ai or .psd form



※ Overseas participants

Please contact us at the following email address for more information.

Exhibition Planning Department / Vanessa Min,
Email. mkc@inaradesign.co.kr / Skype ID: min.vanessa / wechat ID : vanessa23min

Shell Standard Graphic option - Banner

1. Banner Type / Banner types can be manufactured up to 6m long.

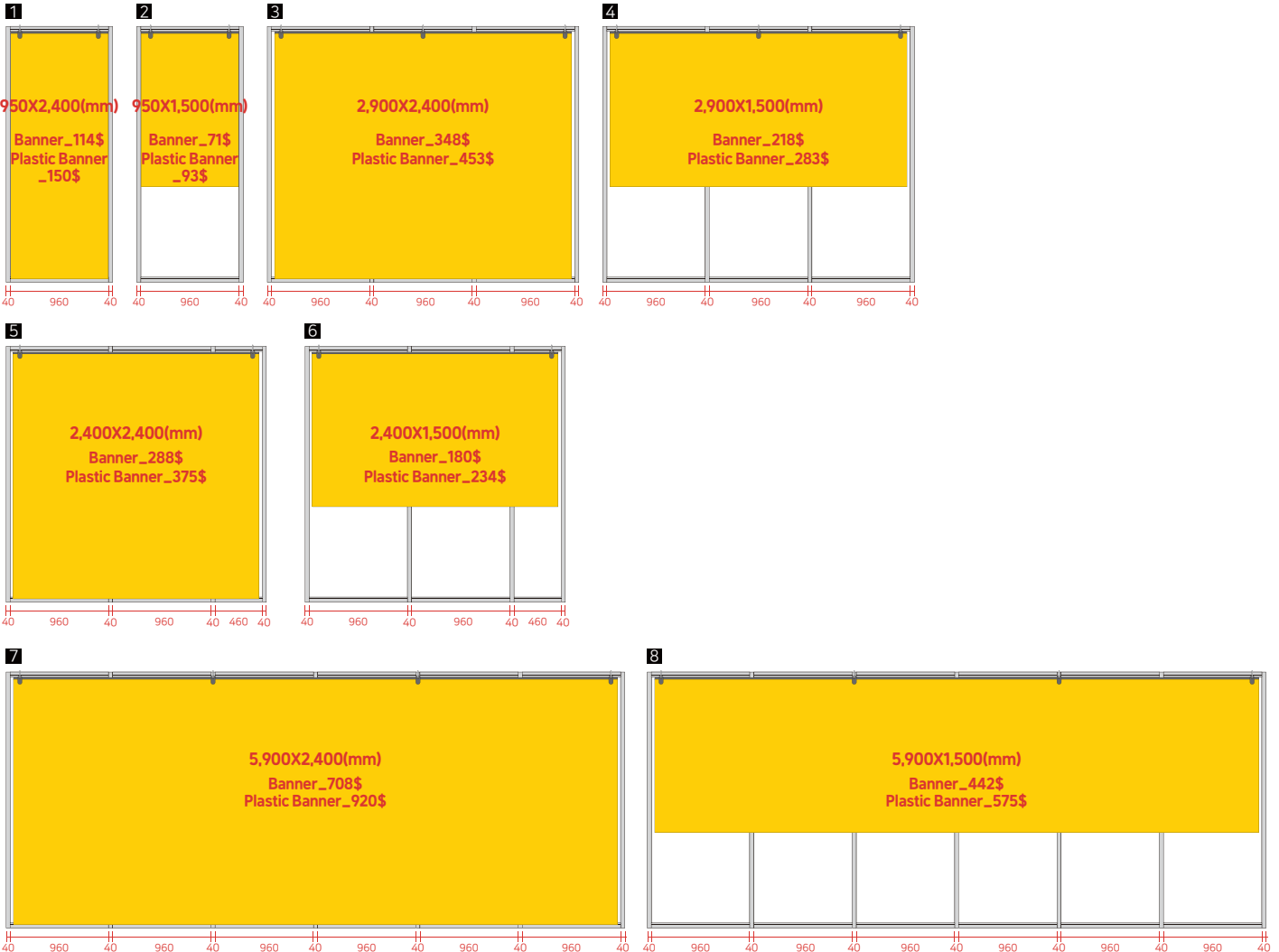

※ Overseas participants

Please contact us at the following email address for more information.

Exhibition Planning Department / Vanessa Min,
Email. mkc@inaradesign.co.kr / Skype ID: min.vanessa / wechat ID : vanessa23min

Shell Standard Graphic option - PVC Graphic

2. PVC Graphic Type

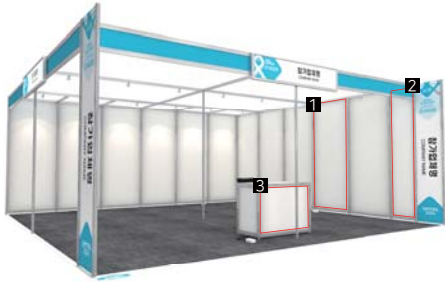

1 Wall_1M

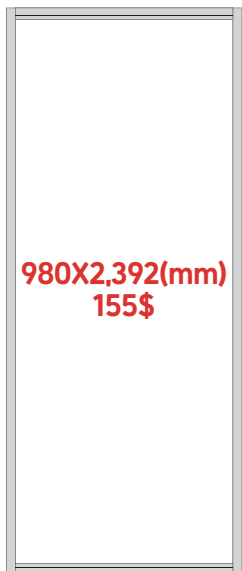

40 960 40

2 Wall_0.5M



40 460 40

3 Information

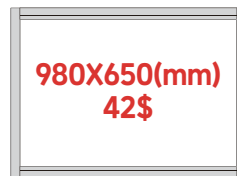

※ Overseas participants

Please contact us at the following email address for more information.

Exhibition Planning Department / Vanessa Min,

Email. mkc@inaradesign.co.kr / Skype ID: min.vanessa / wechat ID : vanessa23min

Shell Standard Graphic option - PVC Graphic + Foam board

3. PVC Graphic + Foam board

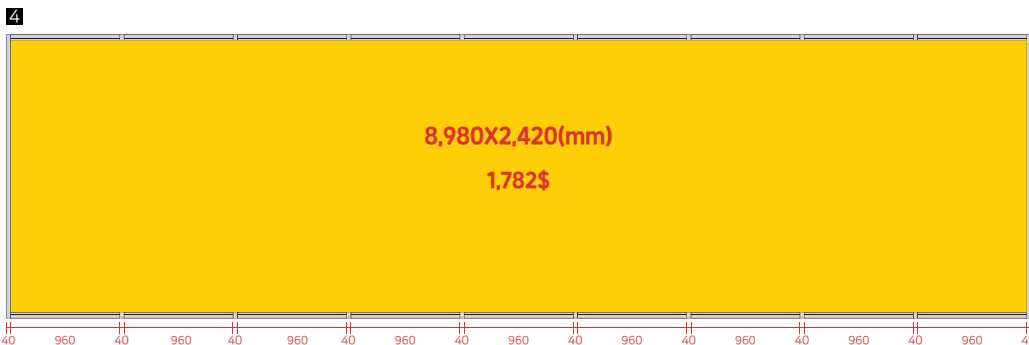
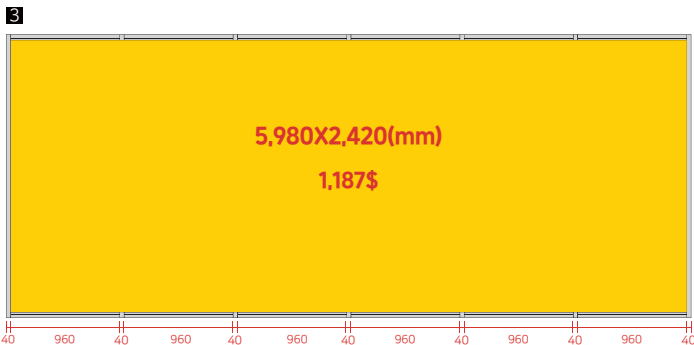
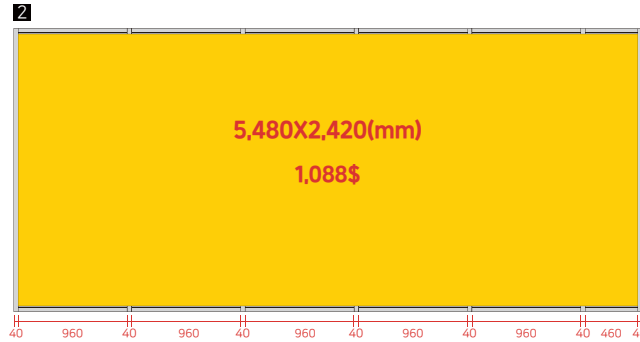

※ Overseas participants

Please contact us at the following email address for more information.

Exhibition Planning Department / Vanessa Min,
Email. mkc@inaradesign.co.kr / Skype ID : min.vanessa / wechat ID : vanessa23min

Display guide line

1 Adhesive printing (material: Adhesive PVC sheet)

→ It can be posted by paperhanger

1

PVC sheet is the printing material which is easy to remove.
As other printing materials are not easy to remove,
using PVC sheet is essential.

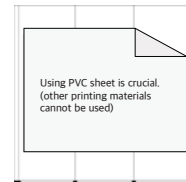

2 Frames or any items, need to be hung on the wall

→Exhibitors can self-build with screws
(the size must be up to 25mm) (No Nail)

2

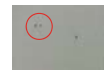
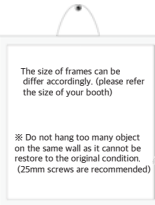

3 Non-adhesive printing(banner, printouts etc.)

→ Exhibitor can be self-posted by tacker or stapler
※Staple must be removed after the show.

3

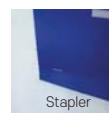
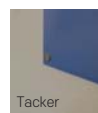
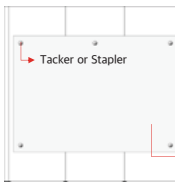

Tacker is better and easy to be used

4 S ring, hanging rods or wire ring can be used to hang

→Exhibitors can self-hang items in the groove on the top of the wall by using wire rings.

4

(S ring and wire rings can be purchased at the hardware store)



- Please read the booth instructions as required.

- In case of damage to the system panel, a restoration fee will be charged inevitably. (Up to \$300 per panel)

Display guide line

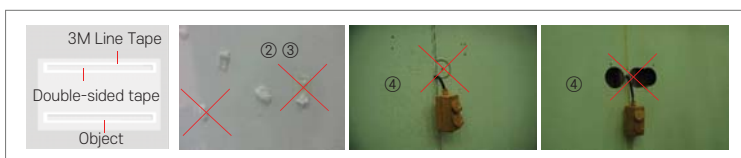

① The construction material(wood wall) is a rental products which must be restore to the original condition after use

② Any superior adhesive strength product such as double-sided tape or super tape cannot be used.

(if you use a line tape from 3M company under the double-sided tape, it can be store to the original condition. Please use this method)

③ Any other high-strength adhesive such as glue gun or silicon are prohibited.

④ Any perforating actions except screw are prohibited.

⑤ if any damage occurs restoring fee will be charged. (maximum \$315 per booth panel)

Wall-hanging TV installing methods

- Cables cannot be molded if you use laptop or any other electronics .

- This walls cannot be perforate for hiding cables or wires. It will be molded by wire molding rods with 3M Line tape

